

CREMO

QUALITY BOATS SINCE 1958

OWNERS MANUAL

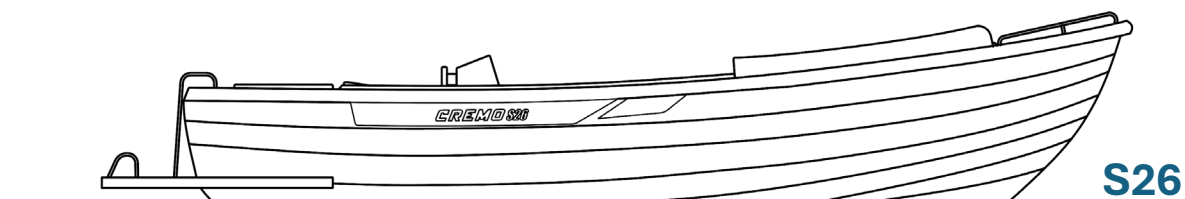
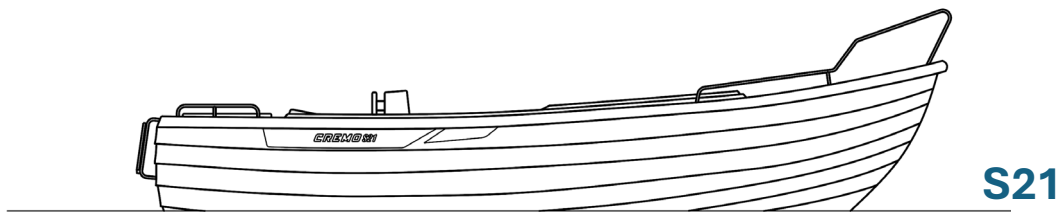

Table of Contents

INTRODUCTION	2
SAFETY SYMBOLS.....	3
DESIGN CATEGORY	4
IDENTIFICATION AND BUILDER ´S PLATE	5
TECHNICAL DATA	7
DESCRIPTION OF SYSTEMS.....	9
ENVIRONMENT	12
STARTING THE ENGINE.....	13
BEFORE DEPARTURE	14
RUNNING THE CRAFT.....	15
OPERATION IN ROUGH SEAS	16
DOCKING	17
ANCHORING	18
MAN OVERBOARD.....	18
REGULAR MAINTENANCE	19
MEASURES BEFORE WINTER STORAGE	20
MEASURES BEFORE LAUNCH	20
RETRIEVING AND LIFTING.....	21
S21 DECK PLAN	22
S21 ELECTRICAL COMPONENTS	23
S26 DECK PLAN	24
S26 ELECTRICAL COMPONENTS	25
DECLARATION OF CONFORMITY.....	26

INTRODUCTION

Congratulations on Your acquirement of Your new boat from Cremo Boats AB!

The owner's manual is intended to provide information regarding safety and practical handling as well as basic maintenance of Your boat and its systems. Please study this manual carefully and familiarise Yourself with the boat and its various systems before your first sailing. The manual is not intended to be a guide to good seamanship or boat safety. If this is Your first boat or if You have upgraded to a new or unknown boat type, it is important to ensure that You are capable to handle the boat before Your first sailing. Your dealer, national sailing federation or organisation can provide You with information regarding sailing and boat-handling courses with competent, licensed instructors in Your area.

Ensure that expected wind and wave conditions correspond to the design category of the boat. Also ensure that You and Your crew are capable to handle the boat in said conditions. Even though Your boat is designed to withstand the mentioned wind and wave conditions corresponding to the design category the conditions still can be dangerous. Only a competent and trained crew with a well-maintained boat can handle such conditions.

The manual is not intended to be a detailed maintenance or trouble-shooting guide. In the event of mechanical or maintenance issues always refer to the boat builder, Your local agent or representative. All maintenance and repairs should be carried out by qualified, experienced boat yards or workshops.

Acquaint Yourself with and follow local regulations regarding crew, equipment and boat handling. In some countries a marine or motorboat driving license or other formal authorisation is required by local or national authorities. Always maintain Your boat and take deterioration due to heavy or improper use into account. Ensure to have appropriate and well-maintained life jackets, safety harnesses, life rafts and emergency flares onboard. Such equipment is mandatory in some countries. All crew members are strongly recommended to be well familiarised with the use and location of all safety equipment before departure. Crew members shall also be well trained in safety routines including man-overboard recovery, fire hazards and personal injury. Basic knowledge in towing and anchoring is also beneficial.

Your boat and its equipment may differ from descriptions in this manual. This may be due to added extra equipment or modifications to the boat model and/or equipment after the completion of the manual. Contact your local dealer or agent for current instruction updates regarding the boat model and its equipment.

Please keep this manual in a secure location and pass it on to the new owner when selling the boat. If the manual is lost or destroyed, a new manual can be ordered from your local dealer or agent.

See the sales agreement for details of the warranty conditions and claim procedures. The certificate of guarantee form should be completed by the owner and sent to the supplier for validity confirmation of the warranty.

Specifications, construction data and illustrations in this publication are non-binding. Cremo Boats AB reserves the right for revisions without preceding notification.

SAFETY SYMBOLS

The owner's manual complies with the standard EN ISO 10240:2020.

Symbols used in this manual are:



Denotes a serious risk that with great probability will result in death or irreparable injuries or injuries with long term effects if proper precautions are not taken.



Denotes a risk that can result in injury or death if proper precautions are not taken.



Denotes a reminder of safety practices or directs attention to unsafe practices which may result in personal injury or damage to the craft, components or to the environment.

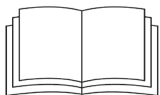

Refers to consultation of instruction manual for given component.



Highlights tips, other information etc. regarding the use of the craft.

DESIGN CATEGORY

Crafts designed in accordance with a design category must be able to maintain stability and buoyancy along with fulfilling other essential requirements when subjected to described parameters of the design category. Also, crafts must have good handling characteristics.

Design Category C:

The craft is designed for operation in wind forces up to Beaufort force 6 (13,8 m/s) and corresponding wave height (significant wave height up to 2 m). Described conditions might be encountered on exposed inland waters, in estuaries, and in coastal waters in moderate weather conditions. Depending on atmospheric conditions, winds can gust to about 18 m/s.

Design Category D:

The craft is designed for operation in wind forces up to Beaufort force 4 (7,9 m/s) and corresponding wave height (significant wave height up to 0,3 m, with occasional waves up to 0,5m). Typically, such conditions might be encountered on sheltered inland waters, and in coastal waters in fine weather. Depending on atmospheric conditions, winds can gust to about 12 m/s.

CE-Marking

Your boat is certified in accordance with relatable parts of EU directive (2013/53/EU) (recreational craft and personal watercraft - directive). The CE-marking means that your boat meets the essential requirements of the above directives.

IDENTIFICATION AND BUILDER ´S PLATE

Identification

Each boat is assigned with a unique identification code (WIN-code). A sign with the code is located on the transom. The identification code is interpreted as per the example below.

SE-CREBAT001D001

SE	Country of manufacture: Sweden
CRE	Manufacturer: Cremo Boats AB
BAT	Boat model
001	Boat number, new building number
D	Month of manufacturing (A=January, B=February, etc.)
0	Year of manufacture
01	Model year

Builder's Plate

The builder's plate is located in the vicinity of the helm. Part of the boat model information is provided by the builder's plate. A comprehensive explanation of the information is, however, provided in relevant sections of this manual.

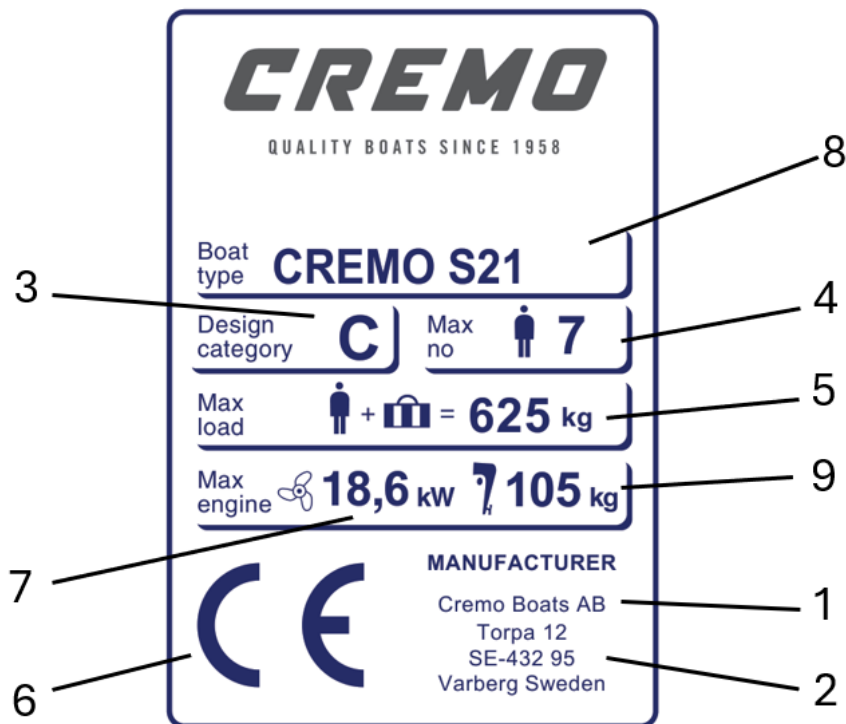

1. Manufacturer's name, registered trade name or registered trademark
2. Contact address; notified body's identification number (if applicable)
3. Craft design category
4. Maximum persons' capacity
5. Maximum recommended load for the builder's plate (kg), m_{MBP}
6. CE marking
7. Maximum power rating (kW)
8. Model name
9. Maximum engine weight (kg)



Do not exceed the maximum recommended number of persons. Regardless of the number of persons on board, the total mass of persons and equipment must never exceed the maximum recommended load. Always use the seats/occupancy areas provided.

TECHNICAL DATA

Dimensions and Weights

	S21	S26
Maximum length, L_{max}	6,30 m	7,85 m
Hull breadth, B_H	2,58 m	2,68 m
Maximum breadth, B_{max}	2,60 m	2,70 m
Draught, T	0,40 m	0,75 m
Weight with maximum load and full tanks, m_{LDC}	1355 kg	2060 kg
Light Craft mass, $m_{LC}^{1)}$	730 kg	1100 kg
Maximum load, $m_{MBP}^{2)}$	625 kg	960 kg
Maximum engine weight	105 kg	125 Kg
Rigging	L	L
Maximum engine power	18,6kW/25hp	36,8kW/50hp
Number of persons	7	10
Fuel tank capacities	-l	-l

1) Including an engine with rigging L

2) Includes persons, luggage, provisions and fuel.



When loading the craft, never exceed the maximum recommended load. Always load the craft carefully and distribute loads appropriately to maintain design trim (approximately level). Avoid placing heavy weights high up.



If the craft is overloaded permanent damage to the engine may occur even if the engine is not engaged. Never operate the craft with an engine that has a power rating greater than the maximum recommended power.



Any change in the disposition of the masses aboard (for example, the addition of a fishing tower, a radar, a stowing mast, change of engine, etc.) may significantly affect the stability, trim and performance of the craft.

S21

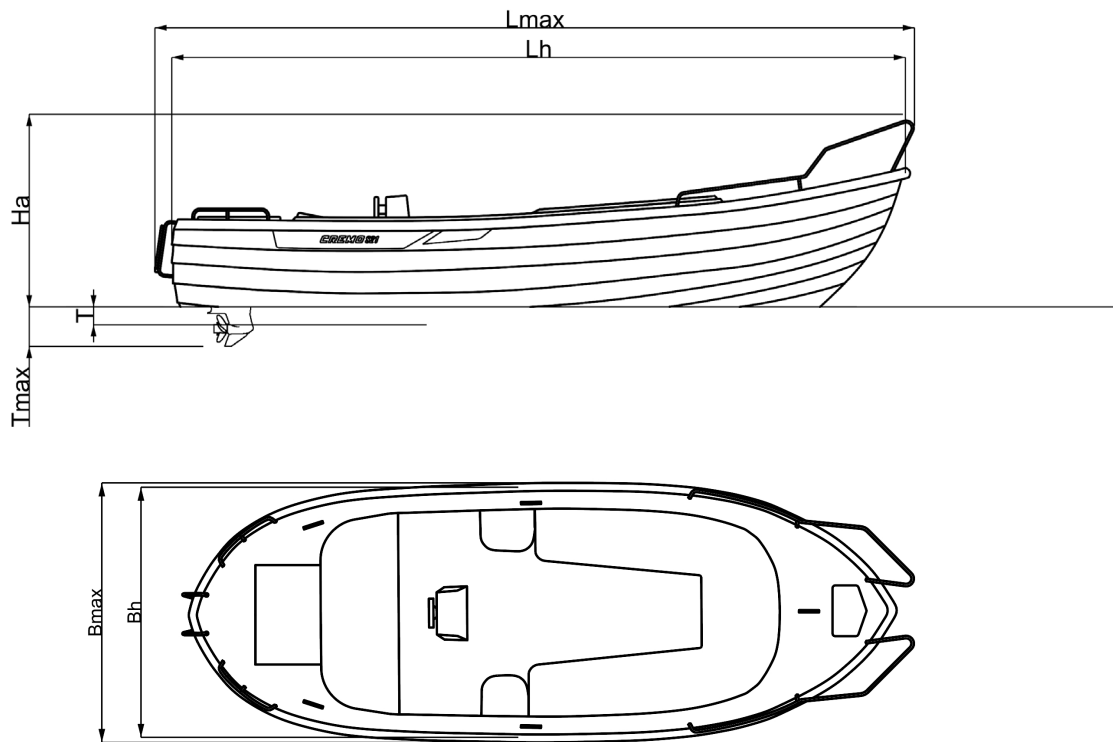

S26

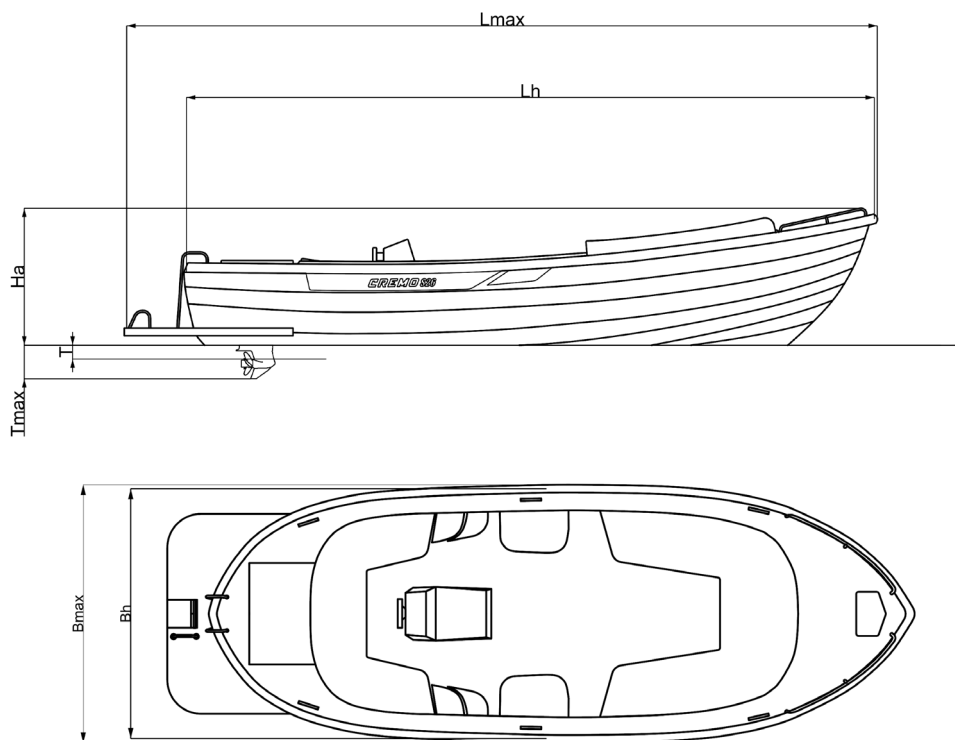

DESCRIPTION OF SYSTEMS

Electric system 12 V WARNING

- Do not work on an energized DC/AC system.
- Improper use of the DC/AC system may result in fire or explosion hazards.
- Improper use of the DC/AC system may result in electric-shock hazards.
- When recharging and disconnecting/reconnecting the battery make sure the main braker is switched off, otherwise sparks may occur.
- Do not modify or change the ampere of the fuses.
- Battery acid is caustic and the gas from the battery is explosive.

General system drawing of electrical components is shown on page 23 and 25.

Bilge and drainage systems WARNING

The bilge system is not designed for damage control! The combined capacity of the bilge system is not designed to pump out the craft in the event of hull damage. NOTE! The pumps must not be run dry for a longer period.

The manual bilge pump has a capacity of 0.5 l per stroke. The electrical bilge pump in the S21 model have a capacity of 37,85 l/min.



Check the function of all bilge pumps at regular intervals. Clear pump inlets from debris. If seacocks are fitted in the fore and aft peak bulkheads, they shall be kept closed and shall only be opened to let water drain into the main bilges.



Avoid pollution! The electrical bilge pumps are, if possible, located in such a way that the risk of accidental discharge of oily bilge water is minimised. The bilge water should be regularly checked for oil, diesel, glycol etc. in order to prevent discharge of these contaminants by the bilge pumps. Bilge water level should be kept to a minimum.

Fuel system



The fuel system has an extra fuel filter on the main supply line. The extra fuel filter is water separating. Prevent damages to the fuel lines.

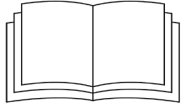

See the manufacturer's instruction manual regarding care and maintenance of the engine's fuel system.



Smoking or using open flame is strictly forbidden during fuel filling. When filling fuel it is advisable that the crew is ashore. Water entering the engine's fuel injection system can cause corrosion and permanent damage to the precision components of the injection pump. For this reason, the fuel filter should be regularly checked for the presence of water. Every so often drain a small quantity of fuel into a suitable container (avoid fuel spillage) and check that no condensation water is present. If there is water in the filter, continue to drain until only clean fuel appears. The fuel system of a diesel engine is sensitive to air bubbles in the fuel. Always refill the fuel tank before it is completely empty. If the system has been run dry it must be bled before the engine can be started again.

Prevent damages to the fuel lines.

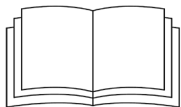

See the engine manufacturer's instruction manual before bleeding the fuel system.

Deck, Fire Plan

Deck plan is shown on page 22 and 24.

Working deck is defined by the area in which persons shall be located when the craft is at sea. Re-boarding ladder location, cleats for towing and mooring are marked in the deck plan.

Fire extinguisher's location is in the deck plan. The fire rating of the fire extinguishers is 13A/70B. When the extinguishers have been used, or have reached their date of expiry, they must be immediately replaced with extinguishers of equal or greater fire rating.

Steering System

If the boat is equipped with hydraulic steering, the oil level in the hydraulic pump for the steering system must be regularly checked. Monitoring and maintenance of couplings, mountings and bearings is to be performed.

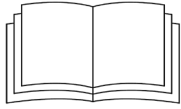

Refer to the manufacturer's manual regarding recommended oil for the hydraulic pump, filling and bleeding the hydraulic fluid as well as maintenance instructions for the steering system.

If the boat is equipped with cable steering the steering system must be regularly checked and its function tested.

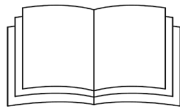

Refer to the manufacturer's manual regarding maintenance instructions for the steering system.

ENVIRONMENT



Be aware of local environment laws, and respect codes of good practice.

The following applies when handling environmentally hazardous substances such as fuel, oils, solvents, grease, hull paint etc.:

- Always take the greatest possible care, read the instructions thoroughly before using each product and handle them with care.
- Make sure that used packaging, cans and similar items are discarded in designated recycling collection points. If you are in any doubt, contact the supplier or vendor of the product.
- Be aware of international regulations against marine pollution (MARPOL) and respect them fully.
- Observe local regulations on sewage discharge. The discharge shut-off valve can be sealed shut.
- The wash from boats can damage the shoreline and create problems for other nearby boats.
- Always adjust the speed to the surroundings to avoid unnecessary wash.
- Always run Your craft at the most economical engine revolutions possible in the prevailing conditions to avoid unnecessary emissions and noise.
- Ensure that the engine(s) is properly maintained in order to preserve noise and exhaust emissions to levels stated by the manufacturer.

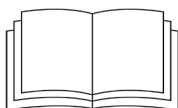

Refer to the engine manufacturer 's manual.

STARTING THE ENGINE

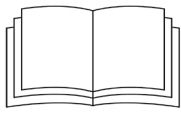

Study the engine manufacturer's manual thoroughly and make sure that You understand how the product shall be used and maintained.

The engine starting procedure can be as follows:

1. Ensure that the engine lever is in neutral.
2. Turn on the ignition and check the fuel level.
3. Start the engine(s) by turning the key.
4. Check gauges for oil pressure, cooling water temperature and battery voltage display all have normal values.
5. While idling, run the engine(s) to operating temperature. Never rev up a cold engine.



Risk of carbon monoxide poisoning.

Be aware of engine exhaust fumes. Under certain conditions (for example turbulence and unfavourable wind conditions) exhaust fumes can enter the boat. Keep idle running of the engine(s) to a minimum. If these problems occur when the craft is underway, do not open hatches and ventilators as this may increase the severity of the problems. Instead, try for example changing speed, trim, course and weight distribution.

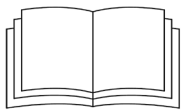

Refer to engine manufacturer 's manual for further information on procedures

BEFORE DEPARTURE



- Never use the reboarding ladder when the engine is running.
- Do not access the engine room when engine(s) is running.
- Stop the engine before inspecting the engine, steering and propellers (stern drives).



- Before leaving harbour, it is important that the craft and its equipment are in seaworthy condition.
- Everybody onboard should wear suitable buoyancy aids or life jackets when on deck. Wearing of buoyancy aid at all times is a legal requirement in some countries.
- Always acquire a local or national marine weather forecast when planning the voyage.
- Always ensure that the tanks are supplied with enough fuel and freshwater with respect to the planned voyage.
- Make sure that items are located in such a manner that they are secured for sailing in rough seas and high winds.
- The reboarding ladder shall be raised and secured during when craft is at sea.
- Gates and guardrails shall be closed when craft is at sea.
- Make sure the steering is properly positioned before engine start.
- Brief the crew members that are to assist during the manoeuvring when the craft leaves the dock.

For safe navigation in all weather and visibility conditions, sound signalling equipment capable of producing the sound signals set out in COLREG (International Regulations for Preventing Collisions at sea, 1972) must be carried on board. Make sure that You have appropriate sound signalling equipment onboard.

RUNNING THE CRAFT

Running a motorboat involves a responsibility, not just to those on board but also to others encountered enroute. Showing consideration for others generates confidence and a sense of well-being at sea. Everyone has the same right to enjoy the sea regardless of which craft one uses.

The physical laws that apply to a boat are different from those affecting a car. A boat must constantly be handled to optimise its seakeeping and handling characteristics and qualities. Running characteristics and the level of comfort while under way are affected primarily by adjusting the craft speed to match the prevailing weather, wind and wave conditions. Doing this, enables a safer and more comfortable voyage for the crew. A planing craft runs almost horizontally in the water at full speed. However, when the speed is reduced the bow rises as the stern settles until the craft levels off again at idling speed. This is normal and is a prerequisite for good performance.

Familiarise Yourself gradually with how the craft handles at higher speeds. Explore how the craft responds to steering inputs and different throttle settings. Conduct tests with highspeed turns, crash stops and collision avoidance manoeuvres in open and safe waters devoid of other vessels. Utilise the knowledge and experiences gathered to enjoy safe, confident and economical running of the craft.

Avoid sudden manoeuvres at high speed except in an emergency or to avoid collision.

Do not access the vicinity of the fore end of the craft like forward deck when the craft is running at high speed.

Shift between forward and reverse gears only at speeds below 3 knots. Preferably, allow the craft to come to a complete stop, and the engine drop down to idle before shifting, as this otherwise strains the engine which may cause the engine to stop and in worst case force seawater backwards into the engine.

A right-handed propeller rotates clockwise, and a left-handed propeller counterclockwise seen from the stern. The rotation of the propeller is critical to accurate and deliberate boat handling. A right-handed propeller pushes the stern of the boat to starboard when the engine is engaged ahead and to port when it is going astern. The direction of rotation of the propeller has a major impact on the turning radius. A right-handed propeller gives a smaller turning radius to port than to starboard. This is called the propeller's "paddlewheel" effect or "prop-walk".

Be aware that Your propellers have considerable propulsion power that provides powerful acceleration. Take this into account to avoid hazardous situations.

Stability of the craft is reduced by any weight added above the main deck.

Be aware that operator's vision from steering position can be greatly reduced by any of the following factors:

- propulsion unit trim angles (on craft equipped with a power trim system on the propulsion unit)
- Hull trim plane angles (on craft equipped with power operated trim planes or trim tabs on the transom)
- Loading and load distribution
- Speed
- Rapid acceleration
- Transition from displacement to planing mode
- Sea conditions reduced visibility (i.e. from rain, darkness and fog)
- Interior lights
- Position of tops and curtains
- Persons or movable gear in the operator's field of vision.

OPERATION IN ROUGH SEAS



Never go out in rough seas if You are uncertain whether the boat and persons on board can cope.

The following simple rules should apply:

- Be well prepared.
- Remember to secure loose equipment.
- Keep hatches closed to minimise the risk flooding of the craft.
- Always have emergency equipment easily accessible.
- Avoid breaking seas close to shore and in shallow waters. Breaking seas can seriously affect the stability of the craft.
- Operate with reduced speed if seas are rough.

Running in head seas

- Adjust the speed according to wave size.
- Adjust the heading according to waves. Avoid encountering waves in transverse direction.

Running in following seas

- Be aware of keeping the bow high in following seas. Avoid forcing the craft through waves. Maintain a low speed. Deploy, if necessary, the sea anchor to reduce speed.
- Planing craft are particularly exposed in rough following seas. The stern rises with the rudder not responding making the craft broach and the bow cut into the sea.

Manoeuvring in narrow surroundings

When manoeuvring in narrow waters engine speed should be kept to a minimum to keep manoeuvres calm and steady. A higher engine speed may be necessary to utilise engine power in difficult wind and current conditions. Quick and precise manoeuvres are important in such conditions to avoid difficult situations due to the craft for example going adrift.

A good rule, before starting a manoeuvre under difficult conditions, is to assess the situations that could arise. Observe wind and current conditions and decide in advance which manoeuvres are to be performed. It is also important to brief crew members on procedures to be carried out.



Be aware that the stability of the craft may be reduced during towing.

DOCKING

Brief the crew regarding the planned dock procedure.

Fenders and at least one mooring line fore and aft must be in place before approaching the dock.

Try docking with the craft against the wind, if possible, as this is the easiest way. Always try to keep the bow exactly into the wind. Maintain as speed sufficient for the craft to respond to the steering. If the bow sways off to one direction, reverse the craft and repeat the manoeuvre. Dock with the bow and get a line ashore quickly.

If docking in transverse wind is necessary, it is a bit more difficult. Do NOT approach parallel to the dock with the intention to allow the craft to be pushed in by the wind. There is always a risk of the bow being swayed towards other boats or the dock. Instead try to manoeuvre the craft so the stern heads into the wind. It is then easier to maintain a steady course. Place a crew member on the fore deck who quickly can turn the bow in desired direction after the craft has been stopped.

Try to avoid sharp movements of the throttle as this could lead to panic manoeuvres. Idling speed ahead and astern is generally adequate.

ANCHORING

1. Study bottom conditions in charts and ensure that the anchor can achieve sufficient grip. Also ensure that anchoring is allowed in the intended area.
2. Chose anchoring spot carefully and ensure that other vessel traffic is not obstructed or that the craft drifts into waterways.
3. Monitor weather forecast for the area and take expected wind, wave and tidal conditions into account.
4. Move the craft to a position 3 to 5 boat lengths upwind the intended anchoring position. Release the anchor until it reaches the bottom.
5. Reverse slowly (at idle speed) towards the intended anchoring spot and ensure that the anchor grip is sufficient. Tighten the anchor line and fasten it to a bollard/cleat.
6. Stand by and check that the craft does not drag or drift. If it does, the anchoring procedure must be repeated as per above.

MAN OVERBOARD

When Man overboard occurs, the reboarding ladder should be used to reboard the boat. The ladder can be unfolded from the water. Location of the ladder is displayed in the deck plans on page 22 and 24.

To make sure of the boats' stability when reboarding, as many as possible of the crew should remain inside the working deck.

REGULAR MAINTENANCE

Some maintenance is required to preserve the finish of the boat, in particular external parts that subjected to sunlight and saltwater.

- Wash the boat regularly with freshwater.
- If the boat is used the whole year, it should be lifted, rinsed and cleaned regularly.
- Clean aluminium details with freshwater and add soap solution if necessary.
- Do not use aggressive cleaning agents.
- To protect and keep the gelcoat fresh, use Marine wax ones a year (more often for saltwater).

Sacrificial Anodes

Sacrificial anodes are used to protect metal from corrosion. The base metal in the anode corrodes instead of the nobler metal it is intended to protect (for instance aluminium in stern drive).

Anodes that are fitted shall be adapted to the specific conditions of the area where the boat is used. There are some general recommendations when choosing anodes. Zinc anodes are to be used in saltwater. Aluminium anodes shall be used in brackish waters. Magnesium anodes are to be used in freshwater.

If the boat is to be used for more than seven days in water for which anodes fitted are not intended, it is worth considering changing the anodes. If the boat has been moved between different types of water, or if the anodes have been exposed to air, the anodes must be checked. If a white crust has formed or the anodes have turned yellow, they must be cleaned. Remove the coating using sandpaper or emery cloth. NOTE! Never use a steel wire brush or ferric oxide type emery cloth, as this could make the anode ineffective. Inspect the anodes regularly and replaced them if they are more than 1/3 corroded.

Stainless steel

Stainless steel is porous. Keeping these pores free from dirt and chlorides is vital to prevent flecks of rust forming on the surface.

Use cleaning agents containing surfactants (e.g. dish-washing liquid). Surfactants reduce surface tension and help remove dirt from deep within the pores in the metal.

Use a rag or sponge for cleaning. If the discolouration remains, a non-scratch pot-scour sponge or scrub sponge can be used.

After cleaning, rinse the surfaces carefully with cold freshwater and dry for best results. NOTE! Do not rinse with warm water as evaporation can cause the discolouration to recur.

Cleaning may have to be repeated several times for a badly stained surface.

Regular cleaning prolongs the life of the products. It is best to clean metal surfaces at least once a month during the season and rinse with cold freshwater after every event the boat is used.

Do NOT use the following for cleaning:

- Steel wool (scratches the surface and leaves small particles of wiring on the surface that may promote rust to form)
- Chlorine solutions and de-ionised water
- Cleaning agents containing chlorides
- Bleach containing hypochlorite (if this is accidentally spilt on stainless steel, rinse it off immediately with plenty of cold water)
- Silver polish

MEASURES BEFORE WINTER STORAGE

- Wash hull and bottom immediately after lifting the craft ashore.
- Cushions should preferably be stored indoors in a dry location. If this is not possible, ensure that cushions are dry and position them on their edges.
- Remove all water from the boat
- Remove and charge the battery. Store the battery in a dry and freeze free location.
- Protect the craft with a tarpaulin or other strong winter cover.
- Refer to engine manufacturer ´s manual for further information on procedures regarding the engine.

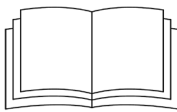

MEASURES BEFORE LAUNCH

- Remove the tarpaulin or winter cover in good time before the launching.
- Wash the hull with a normal boat shampoo and soft brush. NOTE! The shampoo must not contain chlorine.
- Paint the bottom with anti-fouling paint. (If bottom paint is used)
- If the battery has been removed, put it back and connect it. Check the battery for charge and electrolytic level.
- Check all cables, clamps, engine brackets and other brackets.

- Check the steering before launching.
- Check the instrumentation.
- Close all water drainage plugs.
- Check all pipes, hoses and valves.
- Note any frost damages.

RETRIEVING AND LIFTING

Lifting WARNING

Lifting of the craft shall always be carried out by a competent party. Mentioned party shall be adequately insured for conducting lifting operations.

When the straps have been attached to the lifting hook on the crane, they should be secured with lines fore and aft to mooring cleats to prevent the lifting straps from sliding.

Never attach lifting straps to rails or fittings on deck. Use lifting straps that goes all way round under the boat.

IMPORTANT! The lifting beam/frame must have the same width as the boat!

Retrieving using a trailer

Make sure the trailer can handle the boat's weight. Use a dedicated boat ramp. Make sure that the bottom support rollers carry the boat in the correct way and adjust the side supports so that no movement of the boat is allowed. Fix the boat to the trailer with tension straps or similar.



Pay attention to the trailer winch handle, it can spin very fast if winch latch is disconnected.

S21 DECK PLAN

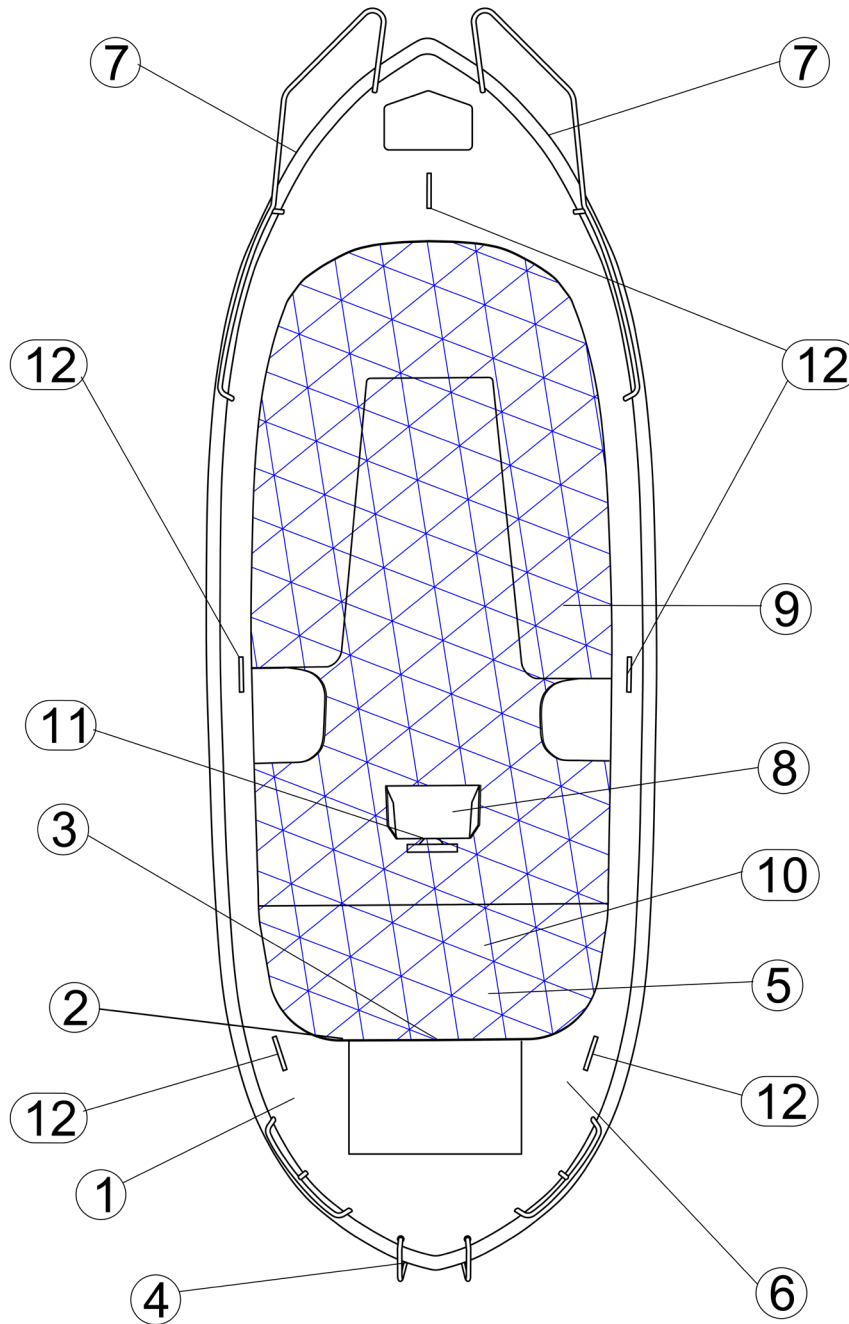

1. Battery
2. Main battery switch
3. Bilgepump
4. Re-boarding ladder
5. Storage for Life raft
6. Top lantern (white 360deg.)
7. Side lanterns (red, green)
8. Fire extinguiser
9. Ventilated storage
10. Drainage
11. Cleats

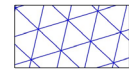

Working deck area



Staying outside working deck area when under way could lead to danger.

S21 ELECTRICAL COMPONENTS

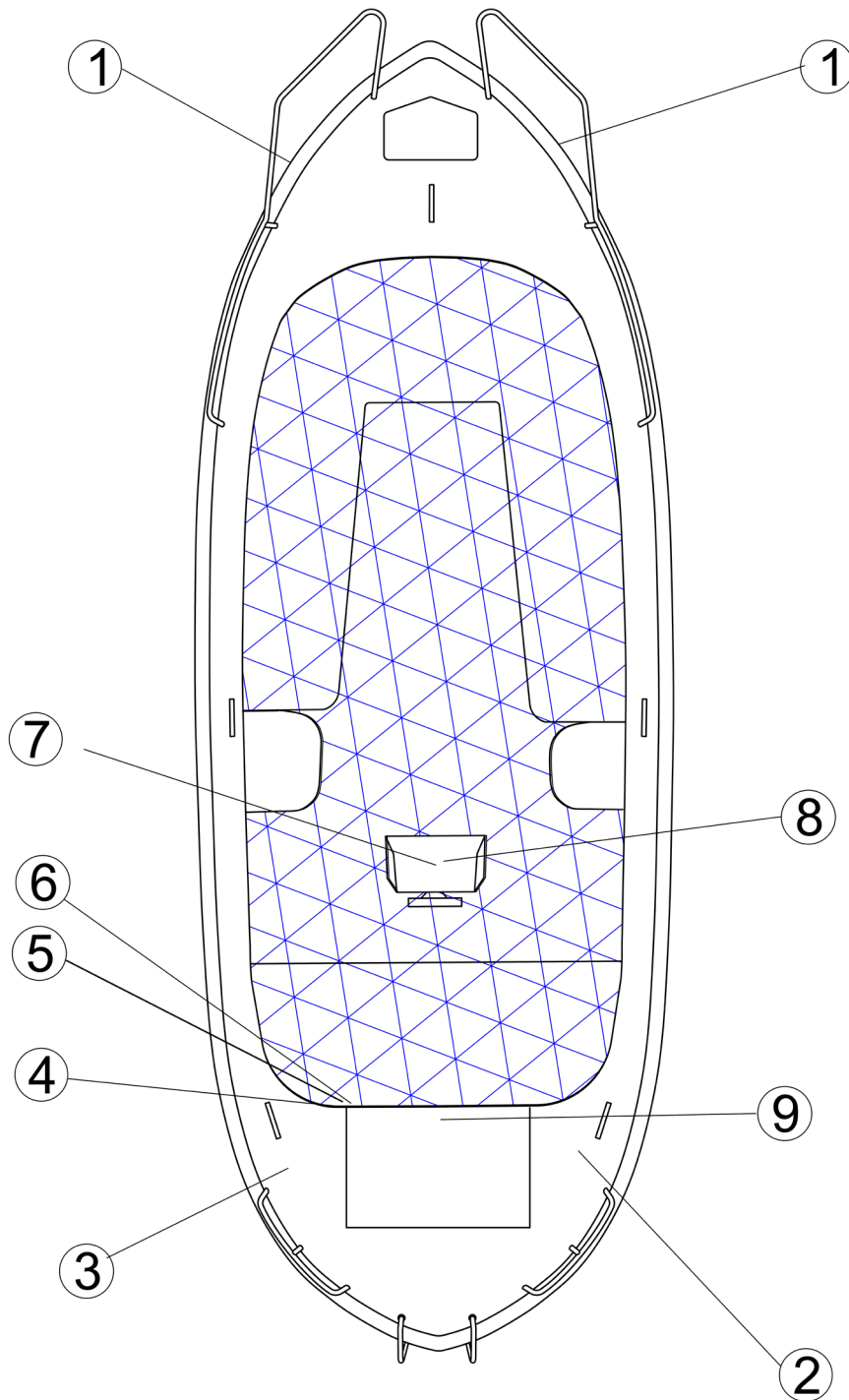

1. Side lanterns
2. Top lantern
3. Battery 12V
4. Main battery switch and 15A Fuse
5. 12V Socket
6. USB-Socket and 3A Fuse
7. Navigation light switch and 7,5 Fuse
8. Bilge pump switch and 3A Fuse
9. Bilge pump

S26 DECK PLAN

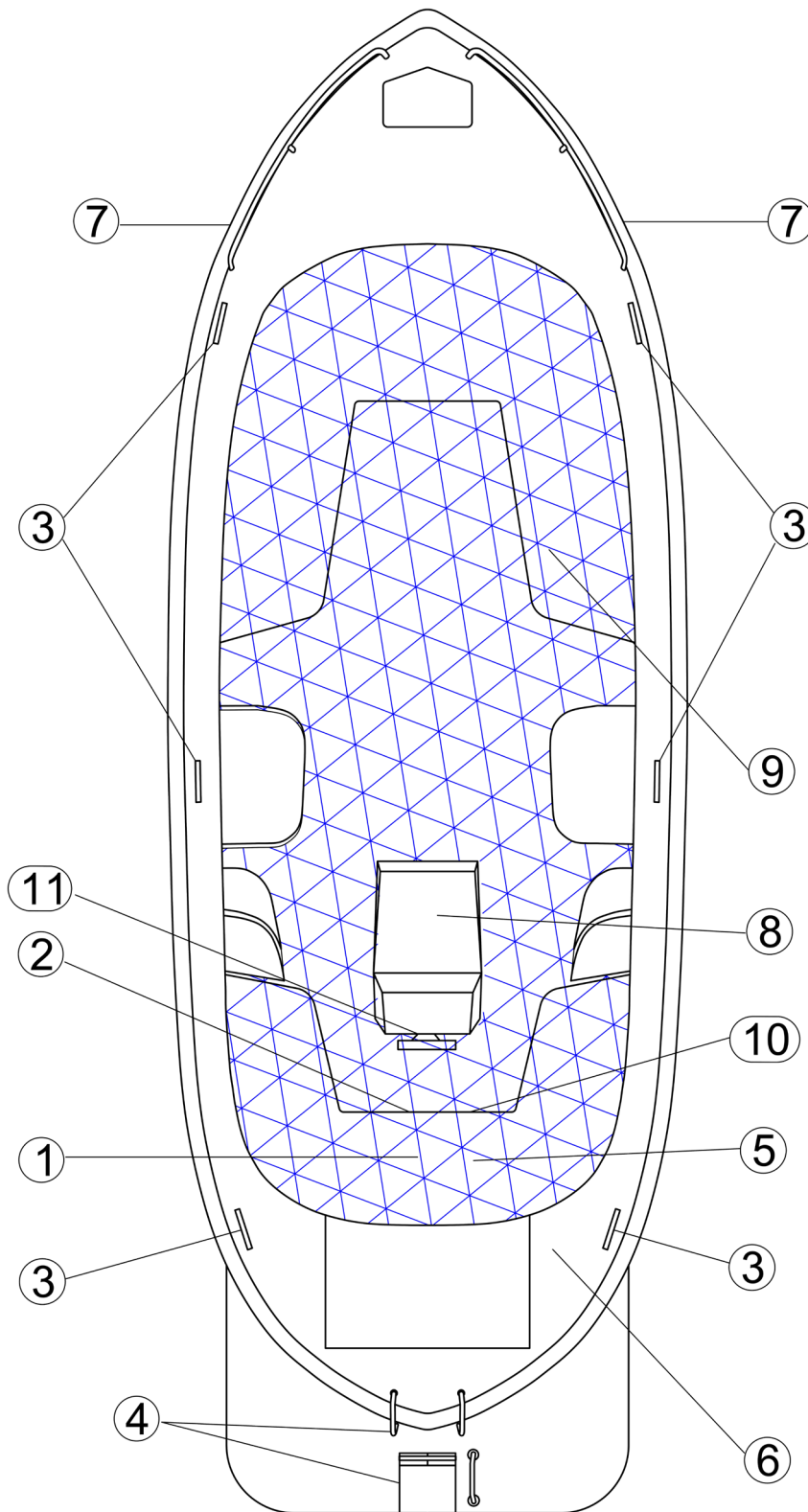

1. Battery
2. Main battery switch
3. Cleats
4. Re-boarding ladder
5. Storage for Life raft
6. Top lantern (white 360deg.)
7. Side lanterns (red, green)
8. Fire extinguisher
9. Ventilated storage
10. Drainage

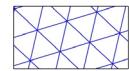

Working deck area



Staying outside working deck area when under way could lead to danger.

S26 ELECTRICAL COMPONENTS

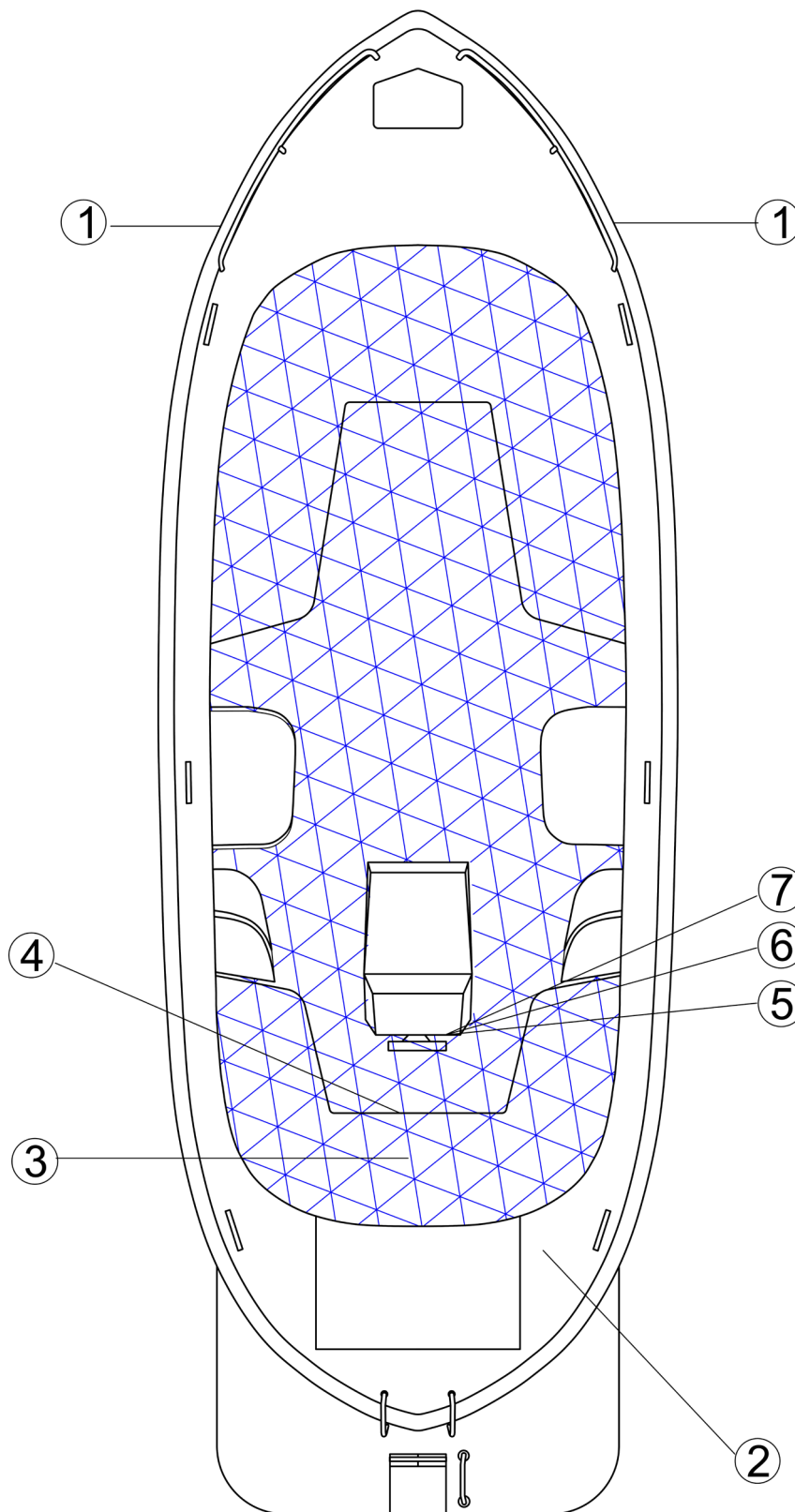

1. Side lanterns
2. Top lantern
3. Battery 12V
4. Main battery switch and 15A Fuse
5. 12V Socket
6. USB-Socket and 3A Fuse
7. Navigation light switch and 7,5 Fuse

DECLARATION OF CONFORMITY

An original copy of the Declaration of conformity is attached to the manual when the craft is handed over to the buyer. Pass it on to the new owner when selling the boat.